



Industry Applications Overview. These applications are listed for applications using Mechanical Plastics, High Performance Plastics, UHMW and Polyolefins.

Contact G S Sales at 317-595-6750 or email www.george@gssales.com Please also visit our website at: www.gssales.com for more information on materials & applications.

Conveyor Industry (SIC 3535):

- * Conveyor Pallet {work platforms}
- * Feed Screws
- * Sprockets
- * Belt Wiper
- * Bearings
- * Product Guides
- * Chain Guides
- * Wheels
- * Wear Pads

Food and Beverage Industries (SIC 3556):

- * Star Wheels
- * Timing Screws
- * Mixer Liners
- * Wear strips
- * Glue Plate Surfaces
- * Bearings
- * Chain & Guide Rails
- * Bin Liners
- * Product Guide Rails

Agricultural Marketplace:

- * Silo Liners
- * Plow Moldboard Covers
- * Feed Bin Chutes
- * Livestock Pen Liners
- * Chain Tensioners
- * Wiper Blades
- * Combine-Skid Covers
- * Flow Gates
- * Drag Flights

Foundry Applications:

- * Squeeze Boards
- * Sand Handling
- * Air Cleaner Liners
- * Hopper Liners
- * Sand Mullers
- * Mold Forms

Dock Fenders Applications:

- * Commercial Docks
- * Boat Rub Rails
- * Boat Trailers
- * Truck Docks
- * Ship Side Rails
- * Ferry Berths

Waste Water Market:

- * Wear Shoes
- * Trough Liners
- * Wear Strips
- * Skimmers
- * Sprockets
- * Truck Liners

Mining Applications:

- * Dragline Buckets
- * Belt Scrappers
- * Front End Loader Liners
- * Bucket Reclaimers
- * Slider Beds
- * Chain Guide Wear Plates
- * Hopper Liners
- * Belt Scrapers
- * Cable Guides



Industry Applications Overview. These applications are listed for applications using Mechanical Plastics, High Performance Plastics, UHMW and Polyolefins.

Contact G S Sales at 317-595-6750 or email www.george@gssales.com Please also visit our website at: www.gssales.com for more information on materials & applications.

Coal Preparation and Power Plants:

- * Reclaimer Liners
- * Washer Liners
- * Launder Box Liners
- * Silo & Hopper Liners
- * Truck & Rail car Liners
- * Belt Scrappers
- * Feeder Liners
- * Remember: Many Power Plants have their own Waste Water Plants.

Lumber Industry:

- * Saw Tables
- * Wear Rails
- * Bearings
- * Guides
- * Truss Table Liners
- * J-Bars
- * Staining Liners
- * Chip Bin Liners
- * Saw Dust & Chip Chutes
- * Under Chain Wear

Steel Mills:

- * Guide Boards
- * Slitting Table Tops
- * Bin Liners
- * Rails
- * Roll Racks
- * Bending Guides
- * Product Protection Chute Liners
- * Bearing Pads
- * Saddle Blocks
- * Plating Tank Wear

Paper Mills:

- * Suction Box Covers
- * UHLE Box Covers
- * Many Paper Mills also have their own Power Generation Plant
- * Foil Blades
- * Water Treatment Components
- * Doctor Blades
- * Roll Racks for Paper

Transportation Industry:

- * Truck Liners
- * Tandem Axle Slide Pads
- * Salt Truck Liners
- * Ship & Truck Bumpers
- * Fifth Wheel Liners
- * Suspension Spring Pads
- * Truck Kick Plates
- * Railroad Car Liners
- * Hitch Wear Pads
- * Snow Plows
- * Railroad Car Parts
- * Bearings

Textile Industry:

- * Lug Straps
- * Shields
- * Tension Bars
- * Pickers
- * Lug Connectors
- * Spindle Rod Clamps
- * Bearings
- * Beater Bars
- * Rollers



Industry Applications Overview. These applications are listed for applications using Mechanical Plastics, High Performance Plastics, UHMW and Polyolefins.

Contact G S Sales at 317-595-6750 or email www.george@gssales.com Please also visit our website at: www.gssales.com for more information on materials & applications.

Recreational Industry:

- * Ski Bottoms
- * Snowmobile Suspensions
- * Bowling Machine Pin Guides
- * Artificial Ice Skating Surface Plate
- * Bowling Alley Ball Returns
- * Snowmobile Skis
- * Water Ride Bumpers
- * Child's Slide
- * Skateboard Rails & Tails
- * Water Slides
- * Roller Coaster Chain Guides
- * Merry-go-round low friction

Chemical Market:

- * Filter Wear Strips
- * Truck Liners
- * Filter Press Plates
- * Storage Silo Liners
- * Pump Components
- * Plating Tank Components
- * Wipers
- * Mixer Liners
- * Mixer Liners
- * Filter Chutes
- * Mixing Paddles
- * Bearings

Concrete Industry:

- * Reusable Forms
- * Mold Liners
- * Hopper Liners
- * Truck Cement Chutes
- * Decorative Mold Components
- * Mixer Components

There are a number of different applications for the uses UHMW and other Mechanical Plastics. We have just tried to itemize a few of the industries and applications. If you have a particular question to suitability or other industries please feel free to question about applications at anytime.



Specific Industry Application Opportunities. These applications are listed for applications using Mechanical Plastics, High Performance Plastics, UHMW and Polyolefins.

Contact G S Sales at 317-595-6750 or email www.george@gssales.com Please also visit our website at: www.gssales.com for more information on materials & applications.

Plastics In The Conveyor Industry (SIC 3535)

There is an ever expanding number of opportunities for mechanical plastics in the Conveyor Industry. Both Roechling and Sustaplast offer a number of products that could help you expand your business in this marketplace.

Areas to Sell:

- Chain Guides
- Sprockets
- Conveyor Pallets{Work Platforms}
- Bearings & Pillow Blocks
- Feed Screws
- Carton Guides
- Belt Wipers
- Wear Pads
- Self Lubricated Rollers & Wheels
- Feed Screws

Materials to Sell:

- UHMW
 - PET
 - Nylon
 - Acetal
- ***A number of grades of each of these materials are possible selections for the market. The material of choice depends on the particular application and requirements{FDA, USDA & etc.}.

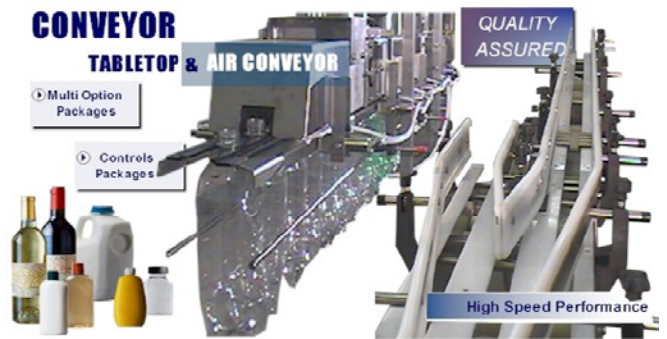

Advantages to Sell:

- Low Coefficient of Friction
- Self Lubricating
- Quieting Effects
- Lightweight
- Low Operating Temperatures
- Non-Stick
- Good Wear Resistance

Where To Sell:

- Conveyor OEM's
- Maintenance Departments of Users of Conveying Equipment. This is a very large diverse number of industries that have opportunities for replacement parts of Conveying Equipment.

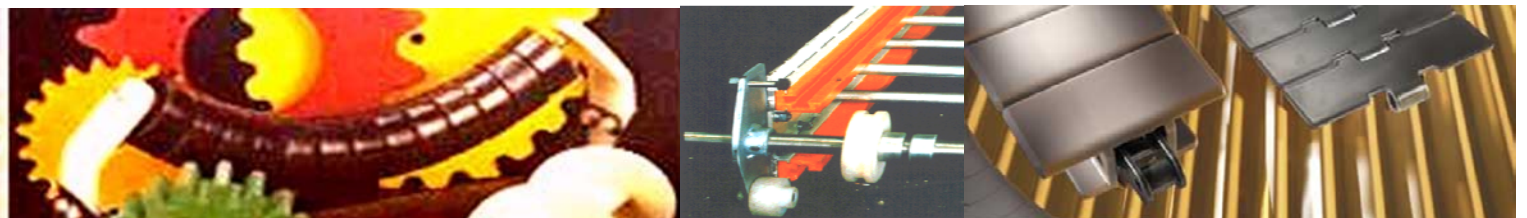

Specific Industry Application Opportunities. These applications are listed for applications using Mechanical Plastics, High Performance Plastics, UHMW and Polyolefins.

Contact G S Sales at 317-595-6750 or email www.george@gssales.com Please also visit our website at: www.gssales.com for more information on materials & applications.

Plastics In The Transportation Industry

There is a huge market in the Transportation Marketplace. Whether it is trucking, mass transportation or automotive we have many opportunities in this market.

Areas to Sell:

- Truck Liners
- Seats
- Tandem Axle Slide Pads
- Snow Plow Mold Boards
- Rail Car Liners
- Salt Spreader Parts
- Fifth Wheel Liners
- Truck Kick Plates
- Ship & Truck Dock Bumpers
- Dash & Interior Truck, Bus & Rail Car Parts
- Tractor Hitch Parts
- Rail Car Coupler Systems

Materials to Sell:

- UHMW
- Nylon
- Kydex
- Acetal

Advantages to Sell:

- Low Coefficient of Friction
- Good Abrasion Resistance
- Non-Stick
- Good Stiffness & Formability
- Good Impact Resistance
- Low Maintenance
- Self Lubrication
- Good Cold Weather Performance

Where to Sell:

- Rail Car Builders
- Truck Fleet Managers
- Semi-Trailer Builders
- Truck & Bus Builders
- RV Manufacturers
- Ship Builders & Rebuilders
- Truck & Bus Seat Manufacturers
- Snow Plow Manufacturers
- Truck Cab Manufacturers
- Dump Truck Contract Carriers

The opportunities in the Transportation Industry continue to grow. Contact the industry manufacturers



Specific Industry Application Opportunities. These applications are listed for applications using Mechanical Plastics, High Performance Plastics, UHMW and Polyolefins.

Contact G S Sales at 317-595-6750 or email www.george@gssales.com Please also visit our website at: www.gssales.com for more information on materials & applications.

Plastics For Use In Waste Water

With the increase of activity created by the Clean Air & water Act passed a couple years past millions of dollars are going into new and upgrades at most waste water plants throughout the country.

Areas to Sell:

- Wear Strips
- Sprockets
- Wear Strips
- Baffles
- Trough Liners



- Wear Shoes
- Splash Plates
- Skimmers
- Bearings
- Chain Guides

Materials to Sell:

- UHMW
- Nylon
- Polyurethane

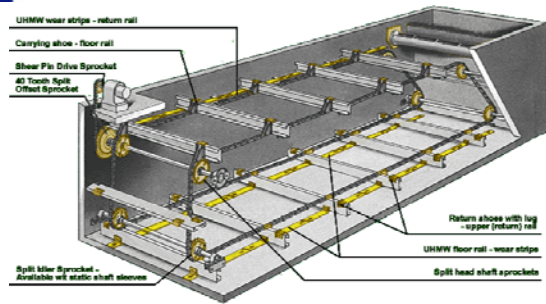
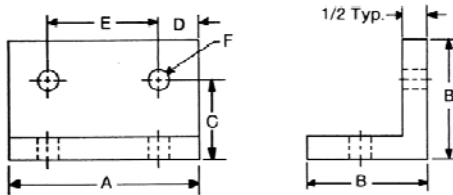

- Low Maintenance
- Low Water Absorption
- Increased Flow Rates
- Good Impact Resistance

- Corrosion Resistance
- Reduced Power Requirements
- Cold Weather Resistance
- Good Abrasion Resistance

Advantages to Sell:

- Municipalities
- Paper Mills
- Chemical Plants

- Paper Mills
- Large Automotive Plants
- Most Large Manufacturing Facilities

Where to Sell:

With the new clean water requirements many large manufacturing facilities have their own waste water facilities. Also, all communities have their own facilities. All these Waste Water facilities require a good number of replacement parts and they buy sheet, extruded products as well as many fabricated parts.

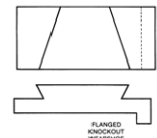
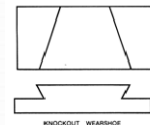
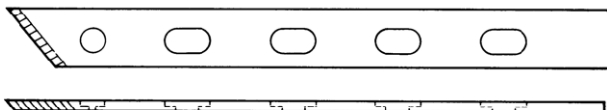

Specific Industry Application Opportunities. These applications are listed for applications using Mechanical Plastics, High Performance Plastics, UHMW and Polyolefins.

Contact G S Sales at 317-595-6750 or email www.george@gssales.com Please also visit our website at: www.gssales.com for more information on materials & applications.

Plastics For The Agricultural Marketplace

Since 1980 the use of plastics in the Agricultural Market has grown enormously. We expect more growth in many new applications in the agricultural applications in the future.

Areas to Sell:

- Silo Liners
- Conveyor Liners
- Drag Flights
- Harvester Skid Plates
- Plow Mold Board Covers
- Chain Tensioners
- Chute Liners
- Flow Guides
- Wiper Blades
- Pulleys
- Livestock Pen Liners
- Sprockets

Materials to Sell:

- UHMW-Virgin & Reprocessed
- Acetal
- Nylon
- Acetal
- HDPE
- Polyurethane

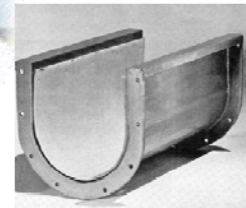

Advantages to Sell:

- Non-Stick Surfaces
- Self Lubricating
- Wear Resistance
- Low Operating Temperature
- Corrosion Resistance
- Impact Resistance
- Extended Machine Life
- Low Maintenance Costs

Where to Sell:

- Equipment Designers
- Agricultural Equipment Manufacturers
- Stockyards
- Race Tracks
- Grain Elevators & Storage Facilities
- Grain Transporters-Trucks & Railcars
- Farmers
- Farm Supply Stores



Specific Industry Application Opportunities. These applications are listed for applications using Mechanical Plastics, High Performance Plastics, UHMW and Polyolefins.

Contact G S Sales at 317-595-6750 or email www.george@gssales.com Please also visit our website at: www.gssales.com for more information on materials & applications.

Plastics In The Chemical Industry

Because of the corrosive environment in processing equipment, a variety of plastics are used in the Chemical Industry.

Areas To Sell:

- Filter Wearstrips
- Wipers
- Plating Tank Components
- Filter Chutes
- Filter Press Plates
- Pump Components
- Mixing Paddles
- Storage Silo Liners
- Truck Liners
- Mixer Liners

Materials To Sell:

- Polypropylene
- UHMW
- PVDF
- HDPE



Advantages To Sell:

- Non-Stick
- Self Lubricating
- Low Coefficient of Friction
- Corrosive Resistance
- Impact Resistance
- Abrasion Resistance

Where to Sell:

- Plating Companies
- Paper Processing Companies
- Power Plants
- Chemical Processing Plants
- Pharmaceutical Manufacturers
- Steel Mills & Steel Processing Centers

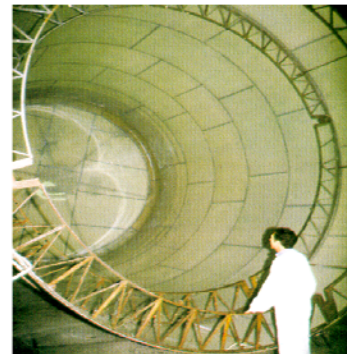

We need to talk with not only the new equipment manufacturers the the processing plants themselves.



Specific Industry Application Opportunities. These applications are listed for applications using Mechanical Plastics, High Performance Plastics, UHMW and Polyolefins.

Contact G S Sales at 317-595-6750 or email www.george@gssales.com Please also visit our website at: www.gssales.com for more information on materials & applications.

Plastics In The Food & Beverage Industry (SIC 3556 & all SIC's in the 2000 range)

A number of plastics that plastics distributions sells are used in the food and beverage market. This is a market that we expect to see continuous new growth in the coming years.

Areas to Sell:

- Star Wheels
- Belt Guides
- Wearstrips
- Bottle Plates
- Guide Rails
- Bin Liners

- Timing Feed Screws
- Conveyor Wheels
- Product Protections Rails
- Chain Guides
- Glue Plate Surfaces
- Mixer Liners

Materials to Sell:

- UHMW
- Acetal
- Nylon
- HDPE
- Polypropylene



Advantages to Sell:

- Self Lubricating
- Soft Handling
- FDA & USDA Acceptance
- NSF Approved Products
- Abrasion Resistance



- Low Temperature Resistance
- Noise Absorption
- Low Coefficient of Friction
- Corrosion Resistance
- Oil-Filled Products Available

Where To Sell:

- Soft Drink Plants
- Food Processing Plants
- Snack Food Manufacturers
- Breweries

- Meat Processing Plants
- Ice Cream Making Equipment
- Ice Making Equipment
- Other Food Processing Equipment



Specific Industry Application Opportunities. These applications are listed for applications using Mechanical Plastics, High Performance Plastics, UHMW and Polyolefins.

Contact G S Sales at 317-595-6750 or email www.george@gssales.com Please also visit our website at: www.gssales.com for more information on materials & applications.

Plastics In Foundries & Steel Mills

Many people ignore the Steel Mills because they associate the past problems of the Steel Industry with the introduction of plastics. This is not true and infact there are many opportunities for us in the Steel Mills and Foundries.

Areas to Sell:

- Squeeze Boards
- Mold Forms
- Sand Muller Liners
- Tub Liners
- Sand Handling & Storage
- Saddle Blocks
- Guide Boards
- Slitting Table Tops
- Roll Drives
- Roll Racks

Materials to Sell:

- UHMW
- HDPE
- Polyurethane
- Nylon

Advantages to Sell:

- Self Lubricating
- Low Coefficient of Friction
- Noise Deadening
- Lightweight
- Abrasion Resistant
- Impact Resistant
- Non-Marking

Where to Sell:

- Steel Mills—You must call on all departments. The majority of materials are sold in the mills, not through the purchasing department. You need to speak with the line superintendents and the maintenance people
- Foundries—You need to speak with the plant superintendent and the model shop to sell materials into this marketplace



Specific Industry Application Opportunities. These applications are listed for applications using Mechanical Plastics, High Performance Plastics, UHMW and Polyolefins.

Contact G S Sales at 317-595-6750 or email www.george@gssales.com Please also visit our website at: www.gssales.com for more information on materials & applications.

Röchling Engineered Plastics Roll & Coil Storage Units

Storage Units Built With Röchling 's Polystone® will not splinter or break.

Provides excellent wear resistance prevents fasteners or framework from becoming exposed.

Provides better than 10 to 1 better lifetime over wood.

Custom machined sizes to your

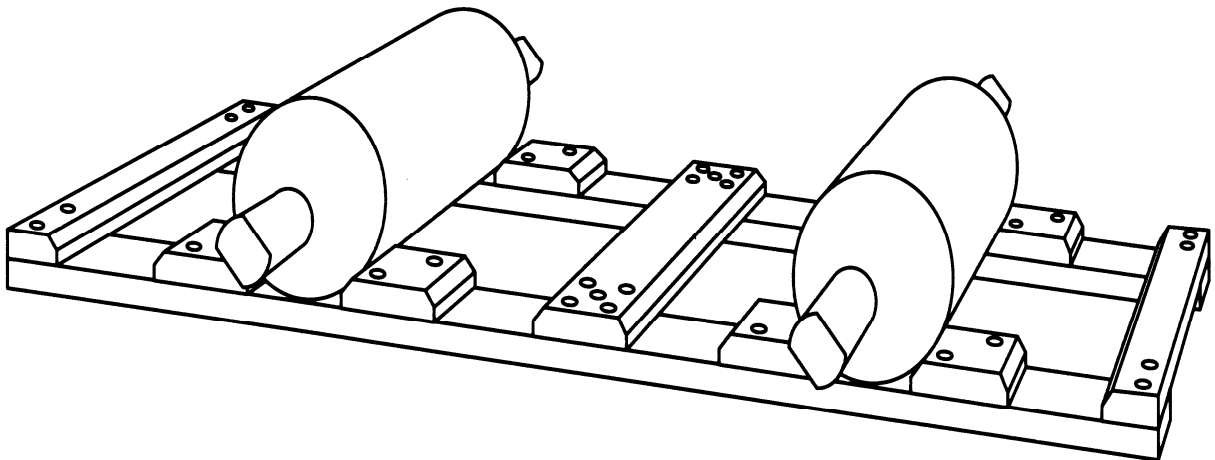
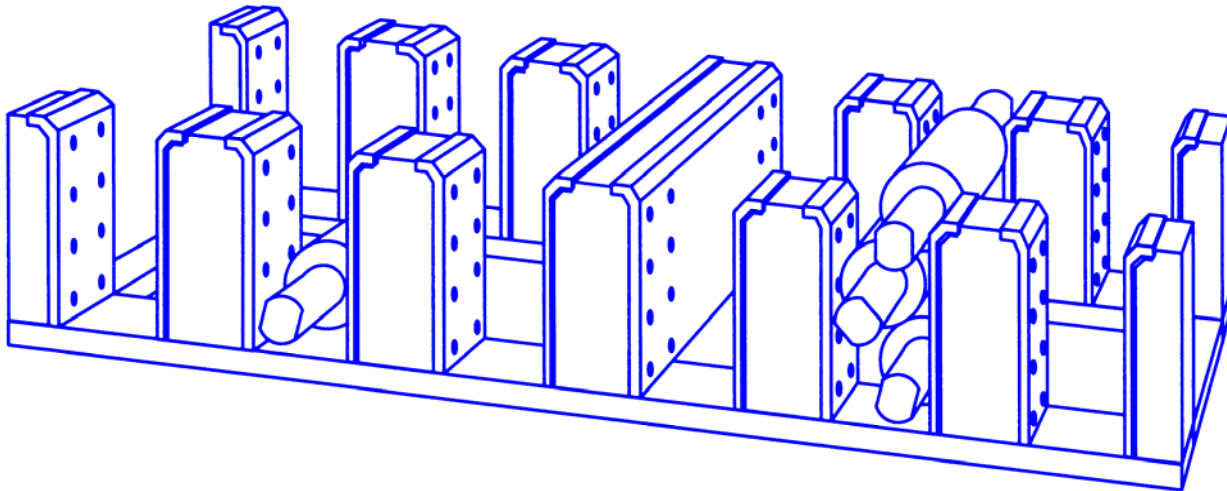
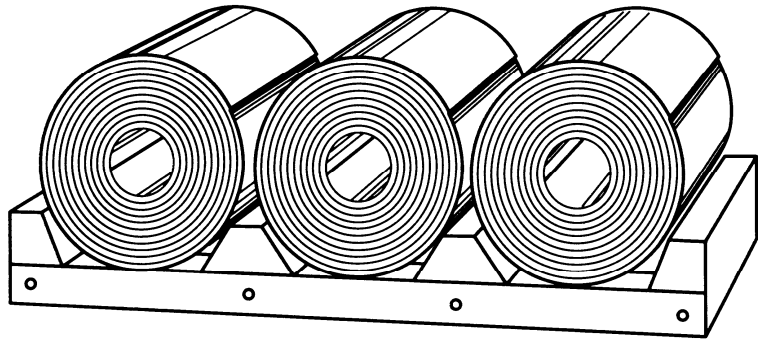

Specific Industry Application Opportunities. These applications are listed for applications using Mechanical Plastics, High Performance Plastics, UHMW and Polyolefins.

Contact G S Sales at 317-595-6750 or email www.george@gssales.com Please also visit our website at: www.gssales.com for more information on materials & applications.

Röchling Engineered Plastics Polystone® Roll Drive

- 1/8 the weight of Steel.
- Polystone Roll Drives can be installed by hand.
- Will not wear the roll end or grinding equipments
- Custom Machined to Replace steel and cast iron units.

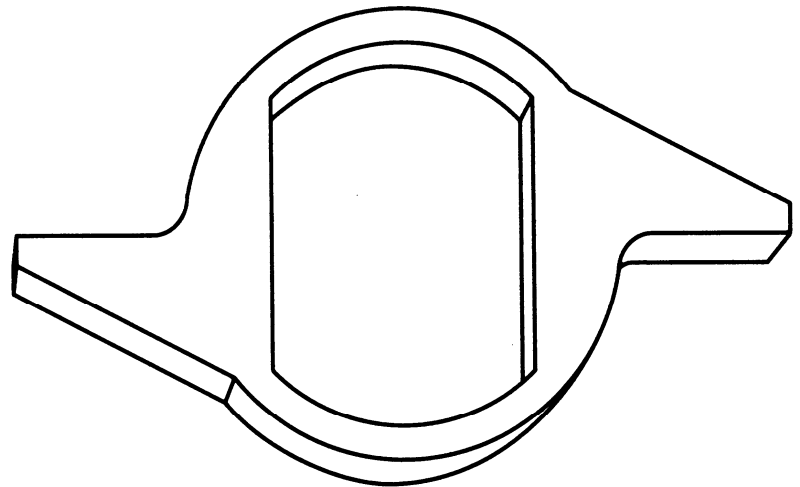
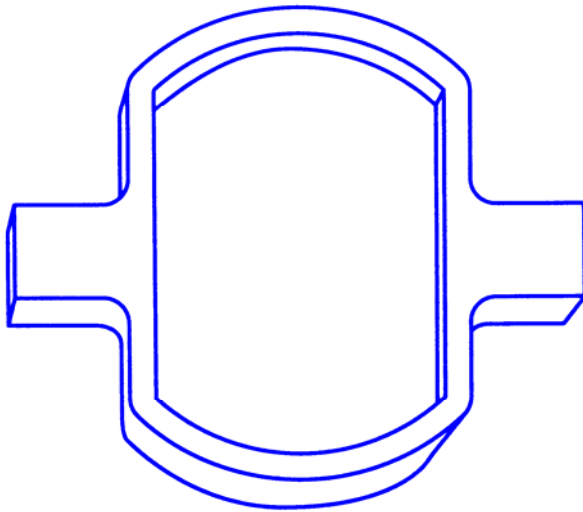
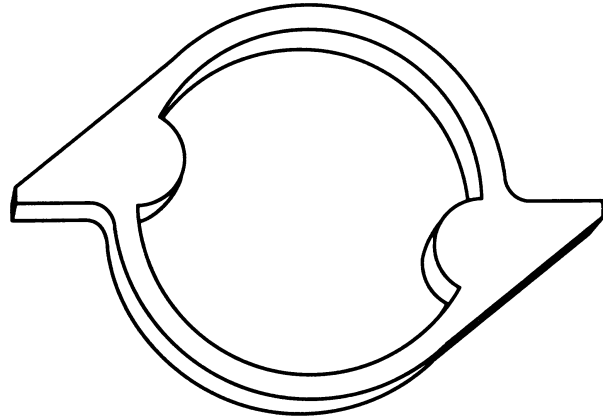

Specific Industry Application Opportunities. These applications are listed for applications using Mechanical Plastics, High Performance Plastics, UHMW and Polyolefins.

Contact G S Sales at 317-595-6750 or email www.george@gssales.com Please also visit our website at: www.gssales.com for more information on materials & applications.

Röchling Engineered Plastics Polystone® Saddle Blocks

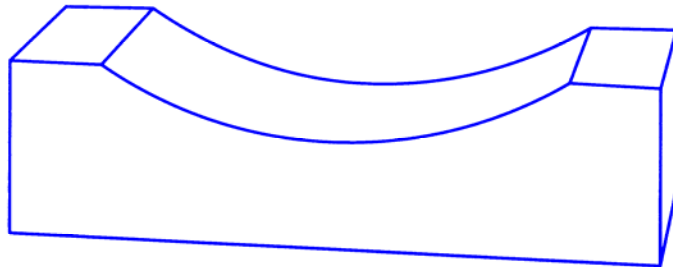

- Polystone® protects the most highly polished surfaces.
- Polystone® will absorb no moisture
- Polystone® saddle blocks are light, 1/8 the weight of steel and easy to move.
- Polystone® resists breaking and gouges in even the toughest environments.

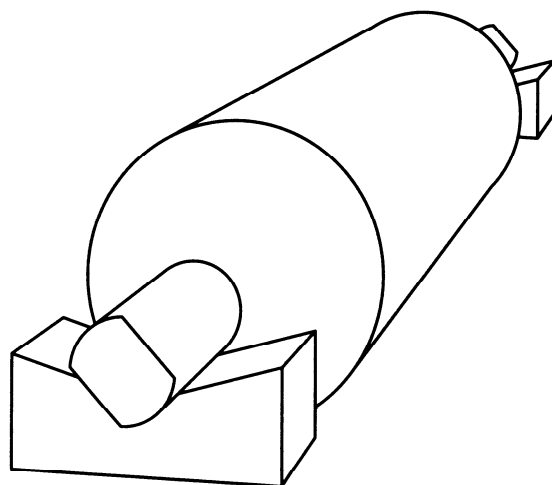
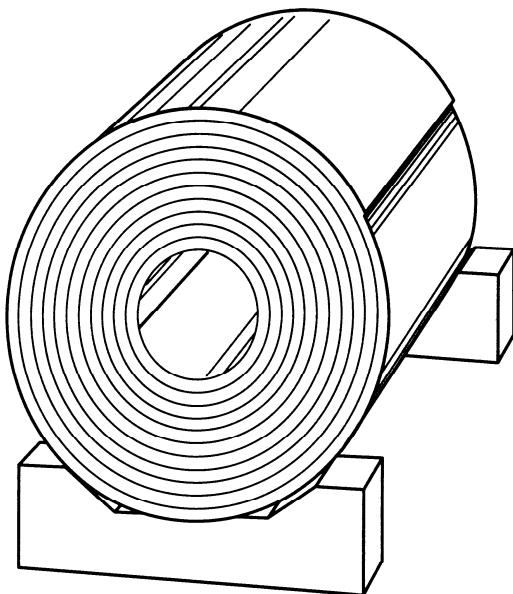



Specific Industry Application Opportunities. These applications are listed for applications using Mechanical Plastics, High Performance Plastics, UHMW and Polyolefins.

Contact G S Sales at 317-595-6750 or email www.george@gssales.com Please also visit our website at: www.gssales.com for more information on materials & applications.

Plastics In The Recreational Industry

Areas to Sell:

- Roller Coaster Chain Guides
- Barricades & Formed Ride Parts
- Snowmobile Sprockets
- Snowmobile Slide Suspensions
- Snowmobile Skis
- Ski Bottoms
- Artificial Skating
- Bowling Alley Ball Returns
- Bowling Alley Kick Plates
- Bowling Alley Pin Guides
- Water Slides
- Merry-Go-Round Center Wear Plates
- Child's Slides
- Boat Parts

Materials to Sell:

- Kydex
- UHMW
- HDPE
- Nylon
- Acetal

Advantages to Sell:

- Self Lubricating
- Low-Coefficient of Friction
- Easily Formed
- Noise Deadening
- Good Wear Resistance
- Good Impact Resistance
- Kydex Many Colors Available
- Corrosion Resistance

Where to Sell:

- Amusement Parks
- Snowmobile Manufacturers
- Ice Skate Stores
- Bowling Alleys
- Bowling Alley Equipment Mfg.
- Skate Board Manufacturers
- Boat Manufacturers
- Water Parks



There are many opportunities in the recreational markets. Look for the supply companies to these companies and to the manufacturers of the equipment for this marketplace.





Specific Industry Application Opportunities. These applications are listed for applications using Mechanical Plastics, High Performance Plastics, UHMW and Polyolefins.

Contact G S Sales at 317-595-6750 or email www.george@gssales.com Please also visit our website at: www.gssales.com for more information on materials & applications.

Plastics As Dock Fenders

A number of plastic materials have been used as dock fenders. These are used in both the ship dock and truck dock bumpers. These materials have replaced wood and rubber and many times are coupled with rubber.

Areas to Sell:

- Commercial Docks
- Private Docks-Ship & Truck
- Large Trucking Company-Facilities
- Small Boat Rub Rails
- Pylon Covers
- Boat Trailer
- Marine Docks
- Ship Side Rails
- Ferries and Their Births
- Buoy Protectors

Materials to Sell:

- UHMW
- HDPE

Advantages to Sell:

- Good Impact Resistance
- Good Wear Resistance
- Environmentally Sound
- Polyethylene Materials Float
- Good Low Temperature Performance
- Low Maintenance
- No Water Absorption
- Cost Effective-Outlasts Wood



Where to Sell:

- Companies with Ship Docks-Port Engineer
- Port Authorities
- Truck Line Terminals
- Rubber Truck Dock Manufactures
- Boat Manufactures
- Truck & Boat Trailer Manufacturers

The opportunities for dock fenders is wide. Almost every building has Dock Fenders, every marina and commercial dock facility on lakes and rivers have Dock Fenders. There are a number of opportunities for those who want to seek them out.



Specific Industry Application Opportunities. These applications are listed for applications using Mechanical Plastics, High Performance Plastics, UHMW and Polyolefins.

Contact G S Sales at 317-595-6750 or email www.george@gssales.com Please also visit our website at: www.gssales.com for more information on materials & applications.

Plastics In The Textile Industry

Much of the manufacturing of cloths and other products has gone overseas and Mexico, there are however many opportunities for us in the United States Textile Marketplace

Areas to Sell:

- PTFE Coated Fiberglass Screen Printing Belts
- Die Pads
- Pickers
- Rollers
- Tension Bars
- Spindle Rod Clamps
- Anti-Stick Heat Seal Tape
- Lug Straps & Connectors

Materials to Sell:

- UHMW
- PTFE Coated Fiberglass-Belts & Tapes
- Polypropylene

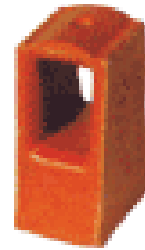

Advantages to Sell:

- Self Lubricating
- Good Impact Resistance
- Good High Temperature Resistance
- Good Anti-Stick Properties
- Good Abrasion Resistance
- Good Release Characteristics

Where to Sell:

- Clothing Manufactures
- Automobile Upholstery Manufactures
- Glove Manufacturers
- Companies Doing Silk Screening
- Shoe Manufacturers
- Manufacturers using Clicker Presses

There are many opportunities in the textile industry. These opportunities are in stamping of materials, screen printing materials, packaging product and on the maintenance of the equipment to do these functions.

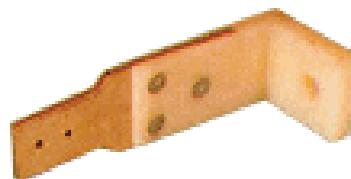
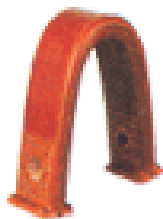



Specific Industry Application Opportunities. These applications are listed for applications using Mechanical Plastics, High Performance Plastics, UHMW and Polyolefins.

Contact G S Sales at 317-595-6750 or email www.george@gssales.com Please also visit our website at: www.gssales.com for more information on materials & applications.

Plastics In Electric Utilities & Coal Preparation

With the handling of Coal there are many opportunities for Plastics. Coal and coal handling have had opportunities for our materials for many years. Many of the applications in Coal Handling as well as Filter Cake and Fly Ash still exist in this market.

Areas to Sell:

- Trough Liners
- Washer Liners
- Hopper Liners
- Chute & Trough Liners
- Belt Scrapers
- Slider Beds
- Truck Liners
- Rail Car Liners
- Silo Liners
- Launder Box Liners

Materials to Use:

- UHMW
- High Density

Because of the extreme wear created by Coal & Coke many times enhanced grades of UHMW {Like Roechling's Matrox, MPG or X-Linked} are used.



Advantages to Sell:

- Non-Stick
- Low Coefficient of Friction
- Good Abrasion Resistance
- Noise Deadening
- Good Low Temperature Performance
- Excellent Impact Resistance
- Corrosion Resistant
- Promotes Flow

Where to Sell:

- Coal Preparation Plants
- Manufacturers with their own Power Generation like automotive plants, paper mills & large manufacturers.
- Power Companies
- Coal Mines
- Rail Car Companies
- Trucking Companies

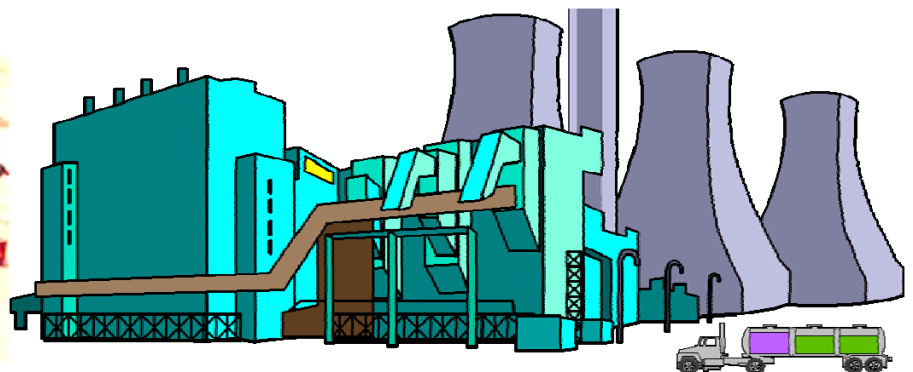



Specific Industry Application Opportunities. These applications are listed for applications using Mechanical Plastics, High Performance Plastics, UHMW and Polyolefins.

Contact G S Sales at 317-595-6750 or email www.george@gssales.com Please also visit our website at: www.gssales.com for more information on materials & applications.

Plastics In The Lumber Industry

The Lumber Industry has many opportunities for a group of plastic materials. They encounter a lot of wear and sticking problems that we can help reduce with the self lubricating properties of many plastics.

Areas to Sell:

- Chain Guides
- Wear Rails
- Chip Bin Liners
- Saw Dust Hopper Liners
- Truss Table Tops
- Truss Table Rollers
- J-Bars
- Saw Tables

Materials to Sell:

- UHMW
- HDPE
- LDPE
- Polyurethane



Advantages to Sell:

- Good Impact Resistance
- Good Noise Deadening Properties
- Good Abrasion Resistance
- Low Coefficient of Friction
- Non-Stick
- Reduced Electrical Requirements

Where to Sell:

- Lumber Yards
- Timber Cutting Operations
- Saw Mills
- Door Manufacturers
- Truss Manufacturers
- Premanufactured Home Manufacturers
- Millworks
- Window Manufacturers



Specific Industry Application Opportunities. These applications are listed for applications using Mechanical Plastics, High Performance Plastics, UHMW and Polyolefins.

Contact G S Sales at 317-595-6750 or email www.george@gssales.com Please also visit our website at: www.gssales.com for more information on materials & applications.

Plastics In the Mining Industry

For a number of years plastics have been used in the mining industries. Engineers are constantly coming up with new applications for plastic materials that save them money & time.

Areas to Sell:

- Dragline Buckets
- Cable Guides
- Slider Beds
- Conveyor Skirt Boards
- Front End Loaders-Liners
- Hopper & Silo Liners
- Belt Scrapers
- Truck Liners

Materials to Sell:

- UHMW
- Polyurethane
- High Density

Advantages to Sell:

- Non-Stick
- Abrasion Resistance
- Low Coefficient of Friction
- Impact Resistance
- Sound Deadening
- Corrosion Resistance

Where to Sell:

- Mines for Coal, Coke, Kaolin, Salt, Iron Ore & etc.
- Stone & Rock Quarries
- Trucking Companies
- Mine Equipment Manufacturers

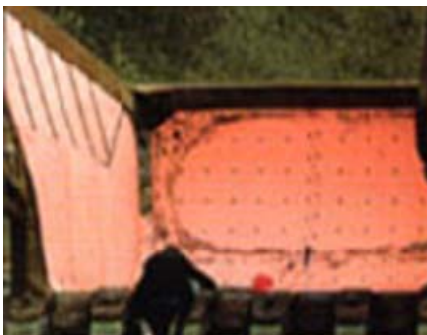
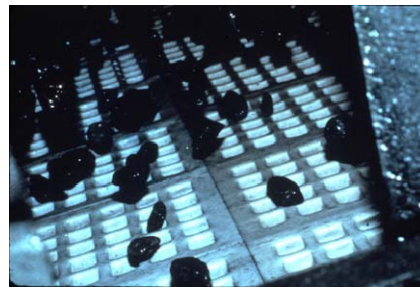



Specific Industry Application Opportunities. These applications are listed for applications using Mechanical Plastics, High Performance Plastics, UHMW and Polyolefins.

Contact G S Sales at 317-595-6750 or email www.george@gssales.com Please also visit our website at: www.gssales.com for more information on materials & applications.

Plastics In The Packaging Marketplace (SIC 3565)

There are many opportunities in the packaging marketplace beside plastic films. I will try to outline a number of of these opportunities for you.

Areas to Sell:

- Conveyor Guide Rails
- Filler Machine Nozzles & Dispensers
- PTFE Coated Belts
- Carton Guides
- PTFE Coated Tapes-For Heat Seal Bars
- Chain Guides
- Rollers
- Bearings

Materials to Sell:

- UHMW
- PTFE Coated Fiberglass
- Nylon
- Acetal
- PET
- High Density
- Low Coefficient of Friction
- Good Anti-Stick Characteristics
- Dimensionally Stable
- Good Wear Resistance
- High Temperature Resistance

Advantages to Sell:

- Packaging Equipment Manufacturers
- Snack Food Manufacturers
- Food Packagers
- FDA & USDA Approved
- NSF Approved Material
- Corrosion Resistant
- Impact Resistant
- Sound Deadening
- Toy & Game Manufacturers
- Contract Packagers
- Book & Magazine Manufactures

