

PALSUN[®]

Flat Polycarbonate Sheet



www.palram.com

Content

PALRAM - Creating Solutions Worldwide	3
PALSUN® - A Modern Transparent Steel	4
Main Benefits of PALSUN®	5
Applications - Construction	7
Applications - Safety Glazing	8
Applications - Advertising	9
Applications - Fabrication	10
PALSUN® Product Range Standard Dimensions & Surfaces	11
Color Range Quantity per Pallet	12
Physical Properties	13
Optical Characteristics Flammability	14
Solar Transmission Properties	15
SolarSmart™ Cool-Light Products	16
Weather Resistance	18
Protection from the the Harmful Effects of UV Radiation	19
Thermal Characteristics	20
Other Physical Characteristics	21
Chemical Resistance Adhesives & Sealants	22
Installation	23-24
Working with PALSUN & PALTUF	25-26



40,000 square meter roof of the Qingdao Railway Station, China.

PALSUN 8mm White-Diffuser sheets were specified to prevent direct sunlight from blinding the crowd and create a pleasant atmosphere.

PALRAM - Creating Solutions Worldwide

PALRAM is a multi-national, market leading manufacturer and distributor of extruded thermoplastic sheets made of polycarbonate, PVC and other materials. PALRAM has 750 employees around the world and operates from production, warehousing and distribution bases spread over 3 continents. PALRAM specializes in extruding thermoplastic sheets and adapting them to provide solutions for agricultural, construction, advertising and DIY projects.

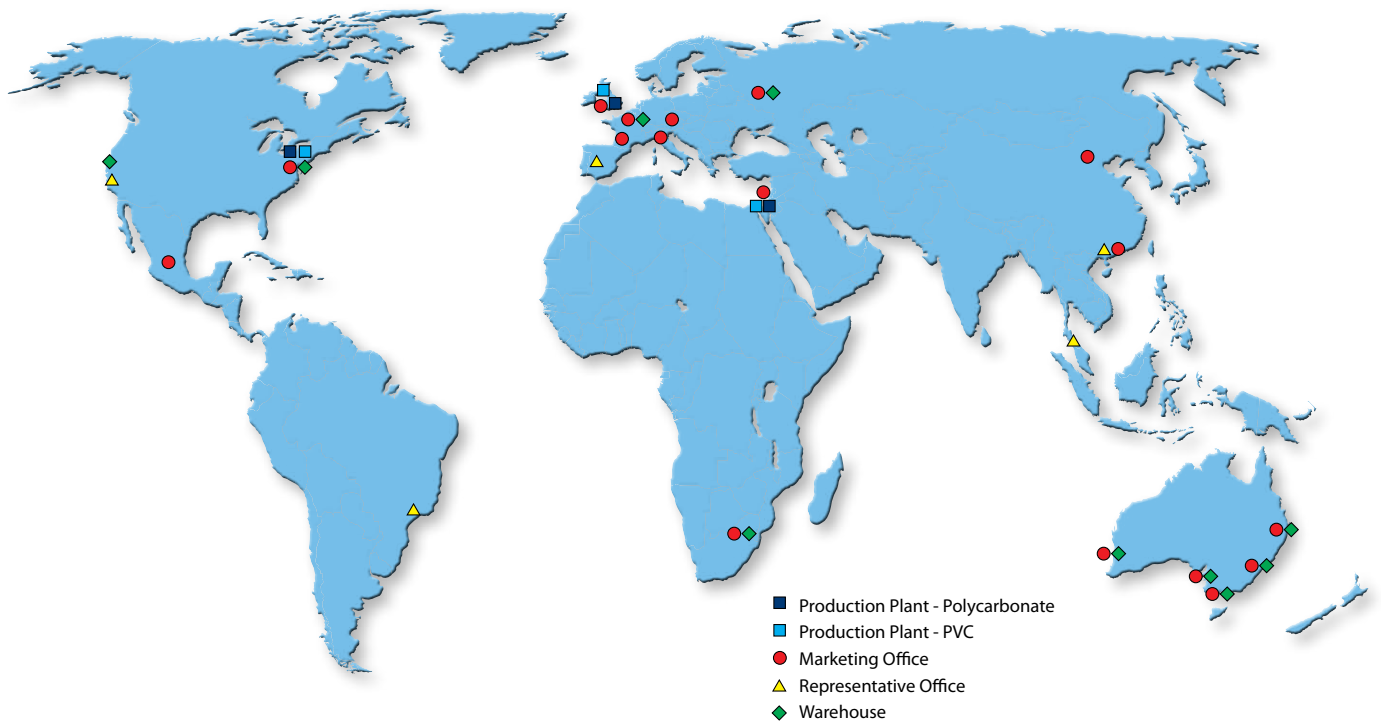

Logistics and Quality Commitment

- PALRAM utilizes the potential of the SAP ERP system to strengthen coordination and to improve control of quality and logistics.
- PALRAM maintains its dedication to the highest internationally recognized quality standards.
- All PALRAM plants have achieved accreditation to ISO 9001:2001 quality assurance standard.

Close Customer Attention

- Many PALRAM advancements have come as a result of the close working relations with its customers.
- As much as it has grown larger, PALRAM constantly responds to the demands of its worldwide customers.
- PALRAM customers benefit from the innovations that emanate from continuous R&D efforts.
- PALRAM provides continuous, reliable technical and marketing support.

Environmental Safety and Health

- PALRAM is committed to working within progressive criteria on the issue of health & safety and to take part in the national and global effort to conserve the environment.
- PALRAM strives to function in all its pursuits in a way that remove or minimize safety and environmental hazards for its employees, contractors, customers and the general public.

PALSUN® - A Modern Transparent Steel

PALSUN combines a special variety of features, allowing a wide range of uses. This highly versatile and long lasting material is the answer to virtually all of the designer and contractor's covering and glazing needs. PALSUN is also readily machined and formed into a wide variety of tough and durable fabrications.

Polycarbonate is one of the most advanced polymers in the field of plastics today. It offers an unequalled combination of properties: strength, transparency, light weight, flexibility, durability, thermal and fire resistance.

PALSUN is transparent as glass, 200 times stronger and less than half the weight. In addition to all of these features, PALSUN can be bent either hot or cold (within limitations). PALSUN's absolute resistance to breakage qualifies it as the best existing safety glazing material available, with impact resistance that is impervious to hammer blows, stones etc.

PALSUN is ideal for use in areas exposed to vandalism and in cases of high impact. As is evident in many buildings around the world - just a few of them displayed in this brochure - PALSUN offers the user possibilities that weren't available previously. PALSUN constitutes a real breakthrough in design concepts and construction methods. The sheets are manufactured to comply with European and U.S. standard specifications.

Built-In UV Protection and UV Resistance

PALSUN flat polycarbonate sheets have an integrated, co-extruded UV protective layer on one side, while PALSUN UV2 offers co-extruded UV protective layer on both sides. This dramatically improves their durability and compliance with outdoor applications. Installation of PALSUN will protect the people, plants, furniture and other objects from exposure to harmful solar UV radiation.

Note: PALTUF is a general-purpose, UV stabilized flat solid polycarbonate without UV protective coating.

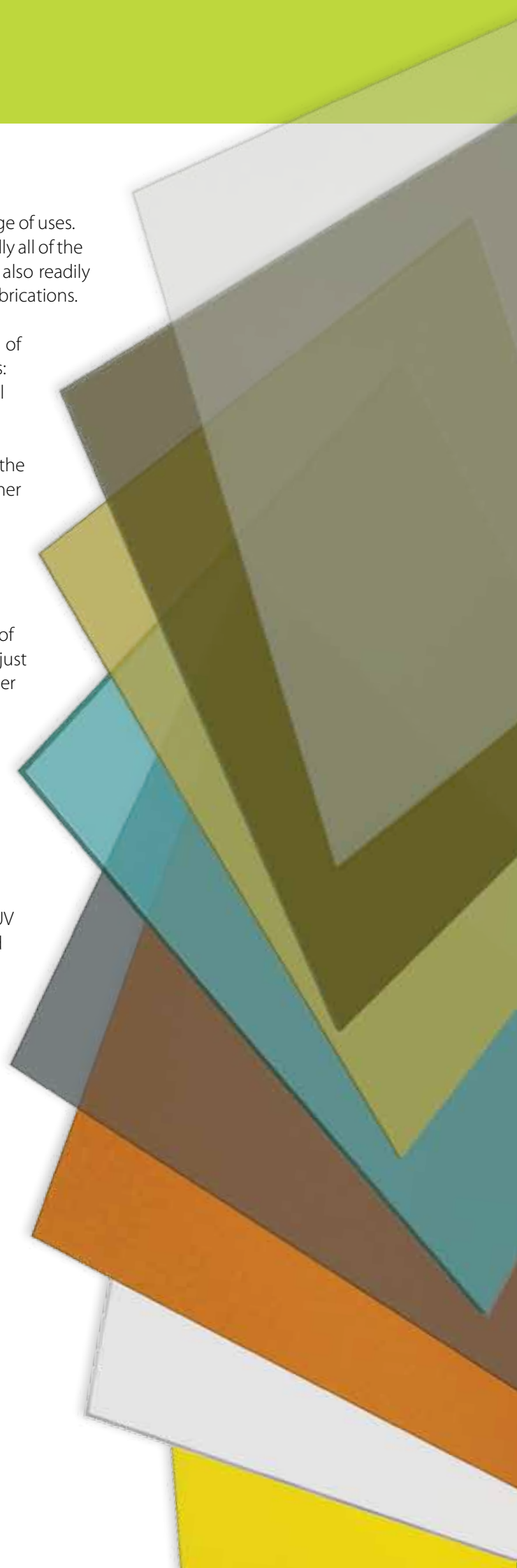

Main Benefits of PALSUN®

✓ Lightweight

Less than half the weight of glass and aluminum.

✓ Transparent

Available in clear with up to 90% light transmission (same as glass). Tinted, colored and embossed PALSUN is also available for a variety of light transmission, light diffusion and surface options.

✓ Weather Resistant

PALSUN Sheets retain their characteristics for years under all conditions.

✓ Thermal Insulation

Both PALTUF and PALSUN exhibit good thermal insulation, considerably better than glass and aluminum.

✓ Resistance to Chemicals

PALTUF and PALSUN Sheets are resistant to various chemicals and other substances. However, they should be prevented from coming in contact with certain materials, as specified by the manufacturer.

✓ Easy to Mount

PALTUF and PALSUN Sheets are easy to work with and install.

✓ Flexible, Formable, Machinable

PALTUF and PALSUN Sheets can be bent either hot or cold, can be thermoformed into an unlimited range of shapes, and can readily be machined and/or fabricated.

✓ Easy to Clean

PALTUF and PALSUN Sheets can easily be cleaned with a 100% cotton cloth using generous amounts of mild detergent and water.

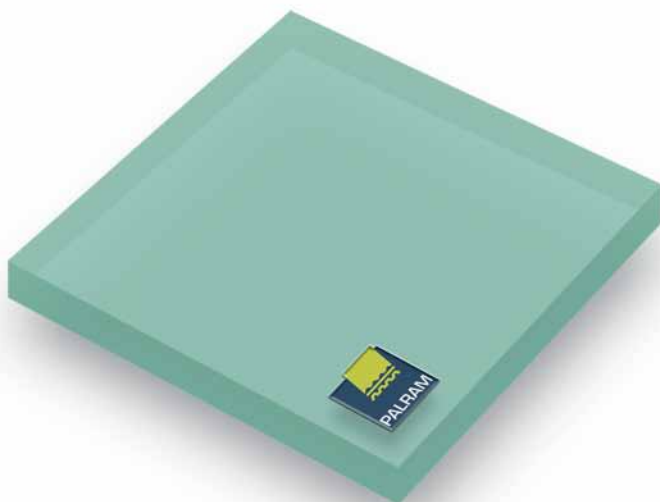



*Athlete runners in the Athens "OAKA" Olympic Stadium.
The stadium's roof, fitted with 24,000 square meters of 12mm PALSUN® Solar-Olympic sheets, was designed by Santiago Calatrava.*

Applications - Construction

- Stadium roofing
- Architectural skylights
- Glazing of windows
- Transparent acoustic barriers
- Ceilings in halls and shopping centers
- Pergolas (covered patios or walkways)
- Sun rooms and conservatory skylights
- Hobby greenhouses
- Skylights/roofs for buildings and halls
- Attic windows



Beijing Ring Road 5 acoustic barrier, China

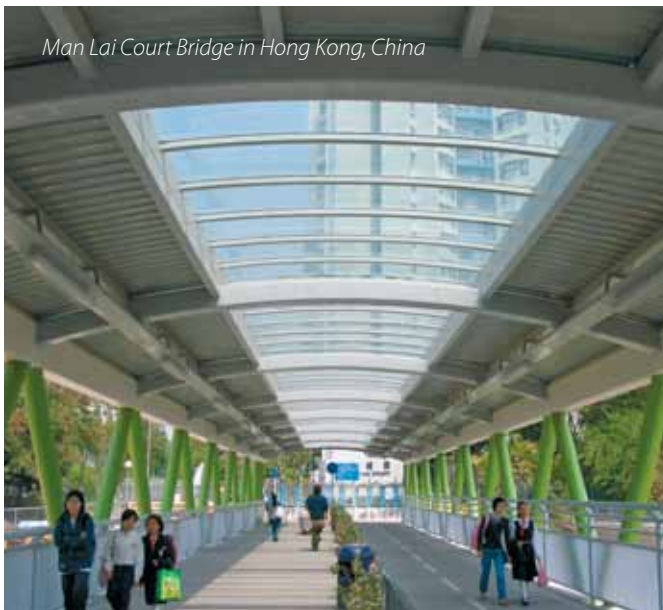

Man Lai Court Bridge in Hong Kong, China



PALSUN canopies at the Hong Kong Ferry platform, China

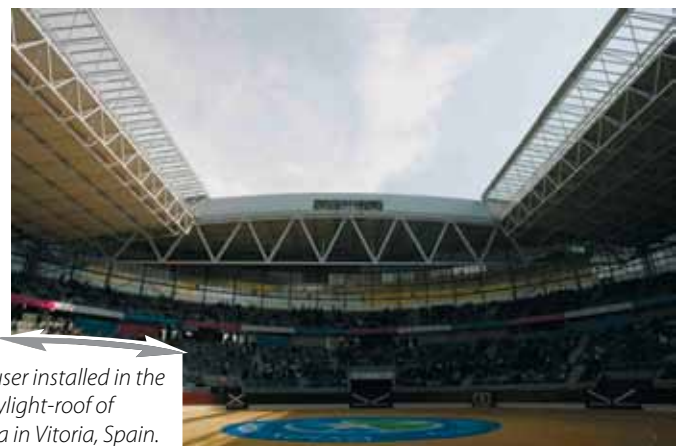
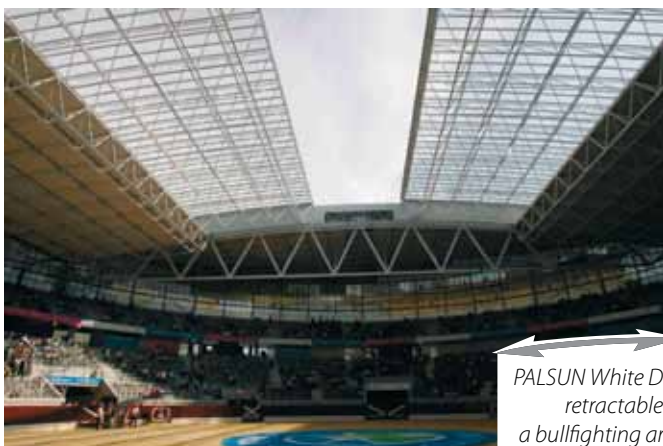

PALSUN White Diffuser installed in the retractable skylight-roof of a bullfighting arena in Vitoria, Spain.

Applications - Glazing

- Safety glazing
- Protective see-through guards for machines in factories
- Glazing in schools and public buildings
- Protective enclosures for bus stops and telephone booths
- Transparent shields for police and security forces
- Glazing in boats, trains, busses and planes
- Windshields for cars
- Eye protection visors for helmets
- Protective shields for armed forces



Armored windows in Jalame border crossing, Israel



Skating rink barriers in Tel-Aviv, Israel

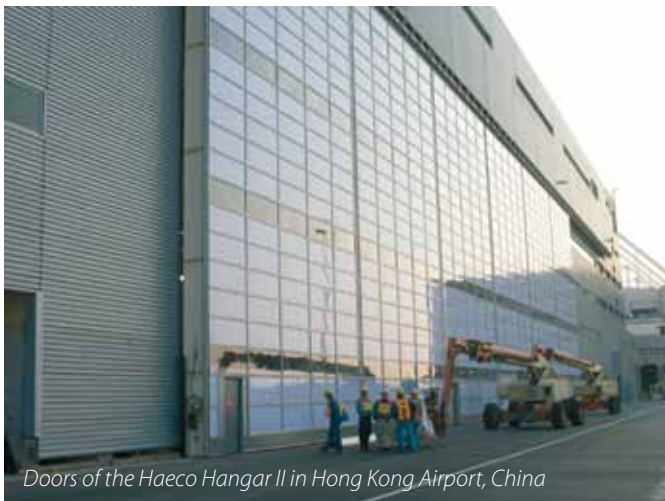

Doors of the Haeco Hangar II in Hong Kong Airport, China



PALSUN security glazing for an armored vehicle

Applications - Advertising

- Long-term, high-impact fabricated signboards.
- Indoor/outdoor light fixtures.
- High-impact, anti-vandal protective covers.



Printed White-Opal PALSUN light fixtures in Arsenal's Emirates Stadium, UK



PALSUN illuminated billboard and direction signage at Beijing subway station, China.

Applications - Fabrication

- High impact fabricated items
- Thermoformed and bent items.
- Vacuum formed items.



Hot-curved 8mm PALSUN® wind-shields on the Hangzhou Bay Bridge in China.



PALSUN 8mm fabricated door sign.

PALSUN® Product Range

Product	Description
PALTUF™	General purpose flat solid polycarbonate sheet (no UV protection).
PALSUN®	Flat solid polycarbonate sheet, UV protected on one side.
PALSUN® UV2	UV protection on both sides.
PALSUN® Embossed*	Embossed surface (E102, prismatic, hair cell).
PALSUN® FR*	Fire retardant, with higher fire resistant rating.
PALSUN® Matte*	Matte finish on one side.
PALSUN® Solar Control*	Efficient heat-blocking, with metallic appearance.
PALSUN® Smart*	See-through sheet with effective filtration of solar heating energy.
PALSUN® Foam	Flat foamed polycarbonate sheet, UV protected on one side.
PALGARD™*	Abrasion resistant on one or both sides.

* With co-extruded UV protection on one or both sides

More options for PALSUN® products:

- Available in embossed, FR (Fire-retardant) or matte sheet variations.
- Available with polyethylene (PE) film protected on one or both sides.
- Supplied with a limited 10 year warranty upon request.

Standard Dimensions*

Thickness mm	Width x Length mm	Surface Type				
		Smooth	Embossed both sides	Matte one side	Hair Cell one side	Prismatic one side
1	1220 x 2440	✓		✓		
1.5	1250 x 2440	✓	✓	✓		✓
2		✓	✓	✓		✓
2.5 - 6	1220 x 2440	✓	✓	✓	✓	✓
8	1250 x 2440	✓	✓		✓	✓
9 - 12	2050 x 3050	✓			✓	✓

*Other dimensions are available on special order, subject to minimum quantity.

Color Range*

PALSUN & PALTUF are available in a wide variety of transparent, translucent, and opaque colors. Opaque colors do not transmit light, whereas clear or tinted transparent colors transmit light and images. Clear and opaque sheets may have a glossy or embossed surface on one side. Opal or Diffuser sheets have 8% to 86% light transmission, depending on the type of tint and the thickness of the sheet. SolarSmart™ cool-light sheets transmit fixed amounts of light (20, 35 or 50%) while reducing heat buildup by filtering near-infrared radiation that generates heat. For more detail Please refer to page 15 & 16.

Transparent

Clear	Solar Grey	Bronze	Red	Blue	Green	Smart Grey	Smart Green	Smart Blue
-------	------------	--------	-----	------	-------	------------	-------------	------------

Translucent

Yellow	Red	Mint Green	White Opal 11-50% LT	White Diffuser 11-50% LT	Solar Ice	Solar Olympic	Solar Control
--------	-----	------------	-------------------------	-----------------------------	-----------	---------------	---------------

Opaque

Dark Green	Red Brick	Black	Dark Blue	Cream RAL 9001	Light Grey RAL 7035	Dark Grey	Brown	Off White
------------	-----------	-------	-----------	-------------------	------------------------	-----------	-------	-----------

* Colors shown above are a reproduction of the actual color. Only actual sample chips can accurately represent the colors. Contact your PALRAM distributor to receive a sample color chip.

** custom colors and light transmissions are available, subject to minimum quantity.

Quantity per Pallet

Thickness mm	1250x2050 Pallet	1220x2440 Pallet	2050x3050 Pallet
1	300	300	
1.5	200	200	
2	150	150	70
3	100	100	50
4	75	75	35
4.5	65	65	30
5	60	60	30
6	50	50	25
8	40	40	20
10	30	30	15
12	25	25	12

Physical Properties

The following table displays physical properties of 3mm (0.12 inch) PALSUN and PALTUF sheets.

Property	Method**	Conditions (U.S. Customary)*	Units - SI (U.S. Customary)*	Value (U.S. Customary)*
Physical				
Density	D-792		g/cm ³ (lb/ft ³)	1.2 (75)
Water Absorption	D-570	24 hr. @ 23°C	%	0.15
Mechanical				
Tensile strength at yield	D-638	10 mm/min (0.4 in./min)	MPa (psi)	62.5 (9,000)
Tensile strength at break	D-638	10 mm/min (0.4 in./min)	MPa (psi)	65 (9,400)
Elongation at yield	D-638	10 mm/min (0.4 in./min)	%	6
Elongation at break	D-638	10 mm/min (0.4 in./min)	%	>90
Tensile Modulus of Elasticity	D-638	1 mm/min (0.04 in./min)	MPa (psi)	2,300 (334,000)
Flexural Modulus	D-790	1.3 mm/min (0.052 in./min)	MPa (psi)	2,350 (340,000)
Flexural Strength at Yield	D-790	1.3 mm/min (0.052 in./min)	MPa (psi)	93 (13,500)
Notched Impact Strength Izod	D-256	23°C (73°F)	J/m (ft-lbf/in.)	800 (15)
Notched Impact Strength Charpy	D-256	23°C (73°F)	J/m (ft-lbf/in.)	800 (15)
Impact Falling Weight	ISO 6603/1b	3 mm (0.12 in.) Sheet	J (ft-lbf)	158 (117)
Rockwell Hardness	D-785		R scale / M scale	125 / 75
Thermal				
Long Term Service Temperature			°C (°F)	-50 to +100 (-58 to +210)
Short Term Service Temperature			°C (°F)	-50 to +120 (-58 to +250)
Heat Deflection Temperature	D-648	Load: 1.82 MPa (264 psi)	°C (°F)	135 (265)
Vicat Softening Temperature	D-1525	Load: 1 kg (2.2 lb)	°C (°F)	150 (300)
Coefficient of Linear Thermal Expansion	D-696		mm/m/°C (in./in./°F)	6.5x10 ⁻⁵ (3.6 x 10 ⁻⁵)
Thermal Conductivity	C-177		W/m K (Btu-in/hr-ft ² -°F)	0.21 (1.46)
Specific Heat Capacity	C-351		kJ/kg-°K (Btu/lb-°F)	1.26 (0.31)
Optical				
Haze	D-1003	Clear Sheet	%	<0.5
Light Transmission	D-1003	Clear Sheet	%	89
Refractive Index	D-542	Clear Sheet		1.586
Yellowness Index	D-1925	Clear Sheet	WI	<1
Electrical				
Dielectric Constant	D-150	50 Hz		3.0
	D-150	1 MHz		2.9
Dissipation Factor	D-150	1 KHz		0.001
	D-150	1 MHz		0.01
Dielectric Strength Short Time	D-149	500 V/s	kV/mm (V/mil)	>30 (>770)
Surface Resistivity	D-257	Keithley	Ohm-cm	5.1x10 ¹⁵
Volume Resistance	D-257	Keithley	Ohm-cm	1.3x10 ¹⁷

* Conditions, units and values in U.S. Customary units are presented in the table within parentheses.

** ASTM except where noted otherwise.

Optical Characteristics

All PALSUN products completely screen out potentially the harmful ultraviolet (UV) radiation (discussed in detail on page 19) and a significant amount of Near Infrared (NIR) radiation. Over the visible range, a typical 3mm (0.12in.) PALSUN and PALTUF clear sheet transmits, on average, 90% of incident light. The % light transmission of a typical 3mm (0.12in.) PALSUN and PALTUF clear sheet is presented in the left-hand graph below. In the visible range of the spectrum, clear PALSUN and PALTUF sheets admit from 87% to 91% of the light, depending on the sheet thickness as shown in the upper left graph.

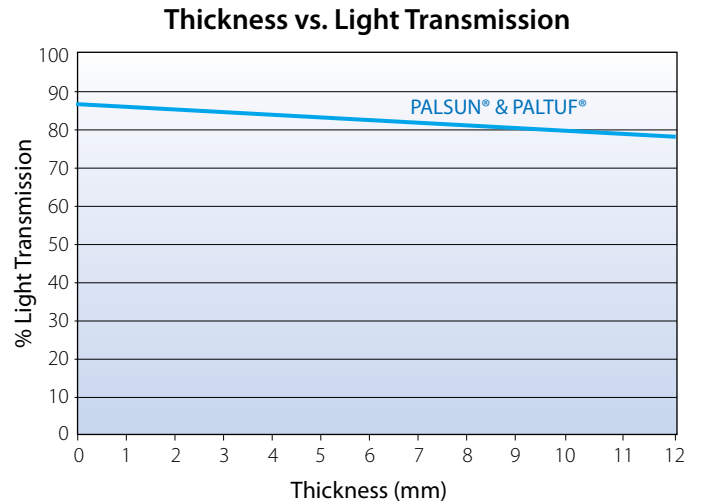
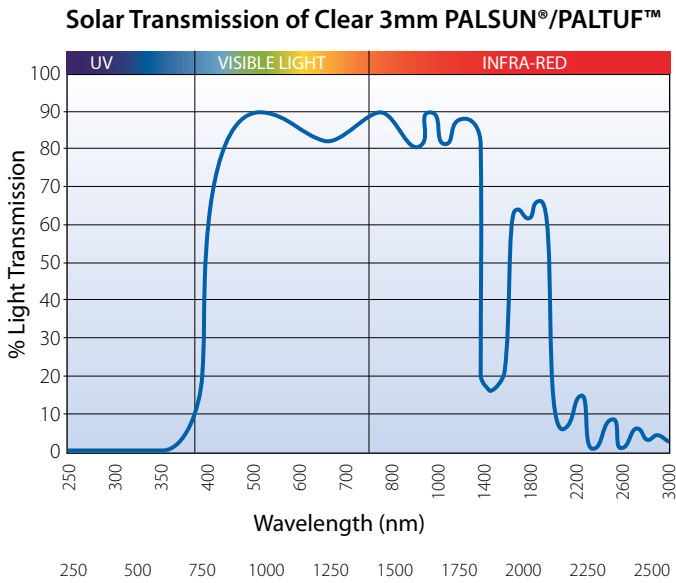

Flammability

The flammability classifications of PALSUN & PALTUF and PALSUN & PALTUF FR, based on tests carried out by certified independent laboratories, are listed below by standard.

PALSUN®	
Standard	Classification*
EN 13501	B, s1, d0
NSP 92501, 4	M1(1 mm)
NSP 92501, 4	M2 (1.5 to 12mm)
BS 476/7	Class 1y
DIN 4102	B1, B2
CSE RF 2/75/A, CSE RF 3/77	Class 1
UL-94	V2 (File e221255)
ASTM D-635	CC1

PALSUN® FR	
Standard	Classification*
UL-94	V-0
ASTM D-2863-87	L.O.I. = 30
AU 1530.3-1982	Ignitability Index = 9
	Spread of Flame Index = 8
	Heat Evolved Index = 10
	Smoke Developed Index = 8

* Depends on thickness. For additional information please contact your PALSUN distributor.

Solar Transmission Properties

Various types of PALSUN can be used to help reduce energy costs throughout the year. Textured, tinted, opal, diffused, and new PALSUN SolarSmart™ sheets feature properties that affect energy efficiency beyond what is depicted on the next page. Each of these products transmit different amounts of direct light in varying levels of light diffusion, which may help to spread the light throughout the structure or enclosure. The sheets also vary in their selectivity index (SI) values, which determines how efficiently they keep heat out while letting more “cool-light” in (See next page for more information on SolarSmart™ products). PALSUN textured, diffused and opal sheets are also suitable for incorporation into light fixtures. They enable designers to deliver the exact quantity and quality of light desired.

PALSUN® Color*	% Light Transmission	% Total Solar Rejection	% Solar Heat Gain	Shading Coefficient
Clear	90	13	87	1.00
Opal	30	60	40	0.46
Bronze	50	35	65	0.75
Bronze	35	44	56	0.64
Bronze	20	54	46	0.52
Solar Grey	50	35	65	0.75
Solar Grey	35	44	56	0.64
Solar Grey	20	55	45	0.51
Solar Olympic	50	37	63	0.73
Solar Olympic	35	48	52	0.60
Solar Olympic	20	59	41	0.47
Solar Control	50	44	56	0.64
Solar Control	35	52	48	0.54
Solar Control	20	67	33	0.36
Smart Grey	55	44	56	0.66
Smart Blue	50	43	57	0.65
Smart Green	70	40	60	0.69

*Values in the table above relate to 3mm Sheet. Further information on additional products is available upon request.

Terminology Used in the Table

Solar Radiation

The solar spectrum ranging from 300 nm to 2400 nm. Included are UV, visible and Near-IR radiation.

Visible Light Radiation

The portion of the light spectrum whose wavelength ranges from 400nm to 780nm.

% Light Transmission (ASTM D-1003)

Percentage of incident visible light that passes through an object.

% Solar Heat Gain (SHGC)

The percent of incident solar radiation transmitted by an object which includes the direct solar transmission plus the part of the solar absorption reradiated inward.

% Total Solar Rejection (%SRt)

The percent of incident solar radiation rejected by an object, which includes the solar reflectance plus the part of the solar absorption, reradiated outward.

$$\%ST_t + \%SR_t = 100\%$$

Shading Coefficient (ASTM E424-71)

The ratio of the total solar radiation transmitted by a given material to that transmitted by normal glass, whose light transmission is 87%. It can be approximately calculated by:

$$\%ST + (0.27 \times \%SA) = \%ST_t$$

$$SC = (1.15 \times ST_t)/100$$

SolarSmart™ Cool-Light Products

SolarSmart™ products have special tints that provide "cool-light" effect through a selective screening of daylight solar energy. Their advanced tints break the traditional linkage between the different zones of the solar spectrum: they transmit high levels of visible light and reflect Near Infra-Red that causes extra heat buildup. Their low shading coefficient values are a result of low IR transmission, not light transmission. They help diminish heat buildup, reduce air-conditioning costs and create a comfortable, well-lighted and pleasing ambience inside the structure. These products are recommended for installations in warmer geographic regions, or for installations that receive direct sun exposure for many hours each day. SolarSmart™ products divide into three groups shown below, each consisting of a different technology and typical efficiency. The various SolarSmart™ tints are integrated into the sheets in the production process and therefore cannot delaminate.

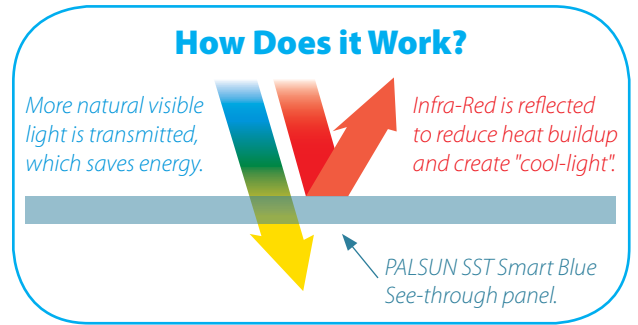

SolarSmart™ Selective Solar Control Technology

Group.....	SMR Solar Metallic Reflective	IRR Infra-Red Reflective	SST Selective See-Through
Features.....	Metallic appearance, effective heat blocking.	Pearlescent colors, highly effective heat blocking.	Glass-like transparency, effective heat blocking.
Availability.....	PALSUN® Solar Control PALSUN® Solar Olympic	Currently available in multiwall sheets.	PALSUN® Smart Grey PALSUN® Smart Green PALSUN® Smart Blue

Effective Heat Blocking Test

The figures below compare 3mm PALSUN sheets with identical 20% light transmission yet very different solar performance. As the graphs show, the Solar Control sheet transmits less Infra-Red energy, while reflecting more solar energy outwards over the entire spectrum. It also absorbs less energy, which means less heating of the sheet itself.

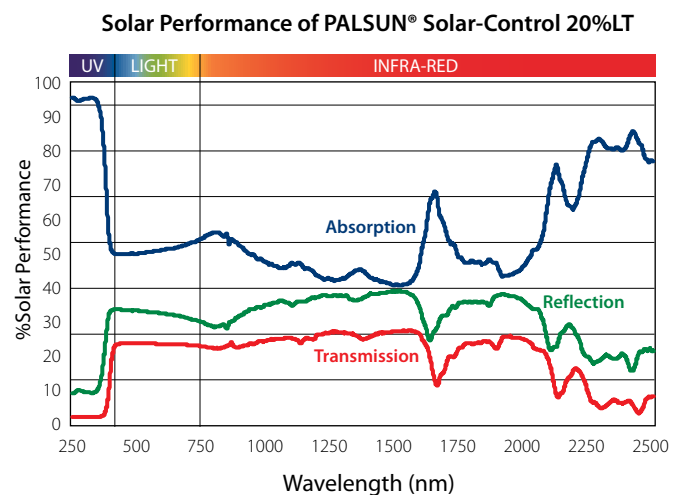
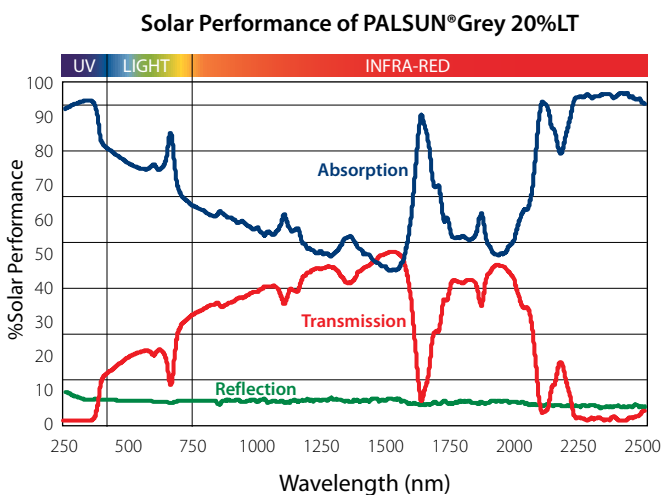



Zhanxi Road Soundproof Tunnel has clear PALSUN skylight integrated into its arched structure. The 1.1 mile tunnel stretches over the Beijing Zoo (China) and minimizes traffic noise for the surrounding environment.

Weather Resistance

Though both PALSUN and PALTUF are impervious to high temperature encountered in the environment, only PALSUN will effectively withstand the affects of solar UV radiation. The changes in optical properties of a typical 3mm PALSUN and PALTUF sheet under accelerated weathering tests are presented in the graphs below. 100 hours of accelerated weathering in a QUV machine are roughly equivalent to 1 year of actual outdoor exposure in Israel or in Phoenix, Arizona (USA). Please bear in mind that changes in optical properties of PALSUN, are hardly perceptible to the naked eye.

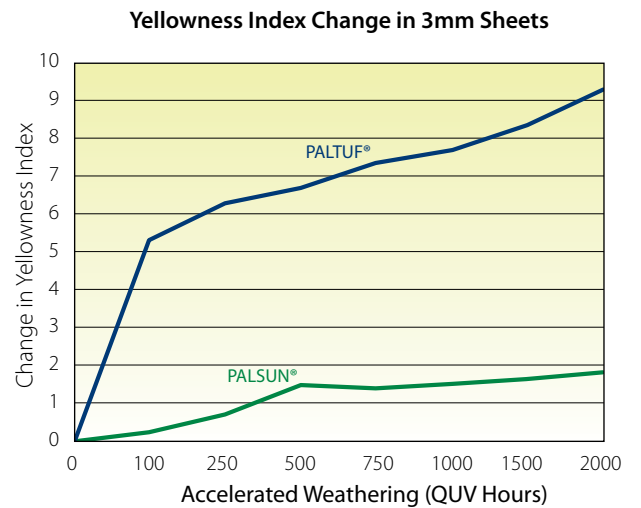
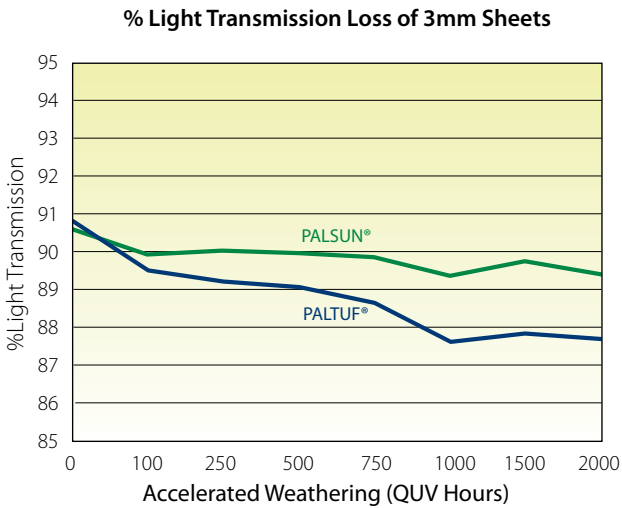

Protection from the Harmful Effects of UV Radiation

Exposure to solar ultraviolet (UV) radiation is widely known as a major health concern by now. The adverse affects were once thought to be associated with solar UV radiation in the 270-320nm (UV-B) range. However, in recent years it has become apparent that exposure to UV-A (320-400nm) is also detrimental. In addition to skin cancer, premature aging has been associated with exposure to UV-A. Both UV-A and UV-B portions of the UV spectrum are blocked out by PALSUN sheets. This screening of harmful UV radiation can be observed in the figure below.

A comparison of the UV protection offered by PALSUN and that offered by sunscreen is depicted in the graph on the right. Note that no barrier is as effective as PALSUN sheet. Activity below PALSUN will be more protected than that offered by proper application of sunscreen, though the latter is sufficient in almost all cases. The key word in the previous sentence is proper. Improperly applied sunscreen or forgetting to apply skin screen will result in undesirable levels of exposure. In addition, note that protection factors are computed on the basis of UV-B exposure. There is as yet no way to compute protection to UV-A exposure.

It should also be noted that formulations that only block out UV-B are still being marketed. When playing or swimming below PALSUN, protection is always complete. When swimming, there is no danger that the protection will be washed away. In the last ten years, it has also been documented that UV exposure can also cause damage to the eyes, specifically to the cornea. Wearing sunglasses manufactured from polycarbonate protects the eyes. However, most people remove their glasses when entering the pool. This is a factor for both public and private pools to consider when contemplating a choice of covering.

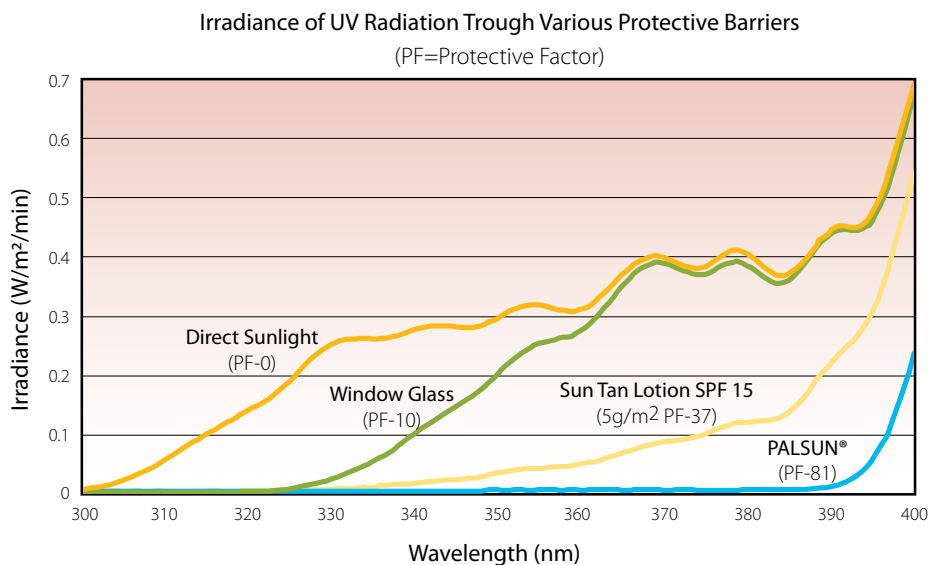

PALSUN Solar Control sheets cover the La Guardia Interchange bus station in Tel-Aviv, Israel. The cool-light sheets create a pleasant atmosphere for passengers.



Thermal Characteristics

Thermal Expansion

The thermal expansion of PALSUN & PALTUF is higher than that of glass. This important factor must be taken into account when mounting the sheets. The graph on the right shows the degree of expansion/contraction as a function of temperature.

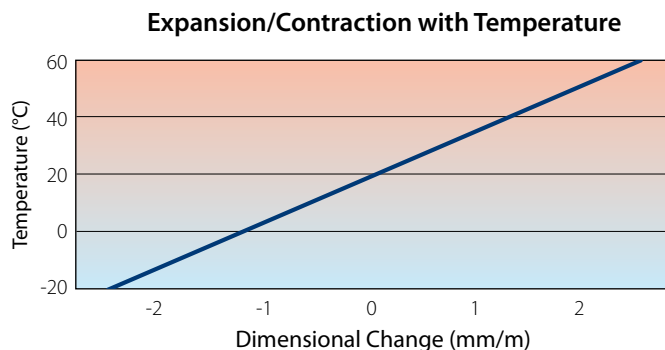

Service Temperature

The temperature range over which the characteristics of PALSUN and PALTUF are retained extends from -50°C to $+120^{\circ}\text{C}$ (-60°F to $+250^{\circ}\text{F}$) for short periods and from -50°C to $+100^{\circ}\text{C}$ (-60°F to $+210^{\circ}\text{F}$) for long periods. This range of temperatures makes PALSUN and PALTUF sheets suitable for use in most climates.

Thermal Insulation

On very hot days, the surface temperature of the sheet might reach up to $+50^{\circ}\text{C}$ ($+122^{\circ}\text{F}$). The U-value characterizes the degree of thermal transmittance offered by a given glazing material, so higher U-values are associated with materials that are poor insulators and result in a greater loss of heat. The following table compares the U-values of glass and PALSUN sheets of equivalent thicknesses. Thicker sheets of a given material will offer greater thermal insulation and be characterized by a lower U-value and reduced heat loss. For any given thickness, the U-value of PALSUN sheet is lower than that of glass. This means that heat loss from the building interior, as well as penetration of heat or cold into a building, will be less if it were glazed with PALSUN than for one glazed with glass. This can result in a significant reduction in energy costs both for heating in winter and air-conditioning during the summer. Note that use of Solar Control sheets will insulate just as well, but will also reduce air-conditioning costs because of Near Infra-Red reflection and reduced heat buildup.

Thermal Insulation of PALSUN® vs. Glass

Thickness		PALSUN U-Value	Glass U-Value
mm	in	($\text{W}/\text{m}^2\cdot^{\circ}\text{K}$)	($\text{W}/\text{m}^2\cdot^{\circ}\text{K}$)
3.0	(0.12)	5.47	5.81
5.0	(0.20)	5.19	5.72
6.0	(0.24)	5.07	5.68
8.0	(0.31)	4.48	5.60
10.0	(0.39)	4.63	5.52
12.0	(0.47)	4.43	5.45



Other Physical Characteristics

Mechanical Characteristics

PALSUN & PALTUF maintain their mechanical properties over their entire performance temperature range. Guidelines for thickness as function of span and wind-load may be found in the appropriate tables on page 23.

Acoustic Properties

PALSUN & PALTUF sheets have excellent sound insulation properties as indicated in the table on the right. The ability to absorb sound waves, together with its impact resistance, has made PALSUN widely used for clear acoustic barriers.

Thickness		Acoustic Insulation
mm	(in.)	DIN 52210-75 RW (dB)
4	(0.16)	24
5	(0.20)	25
6	(0.24)	26
8	(0.31)	28
10	(0.39)	30
12	(0.47)	31



Urban acoustic barrier, Hong Kong

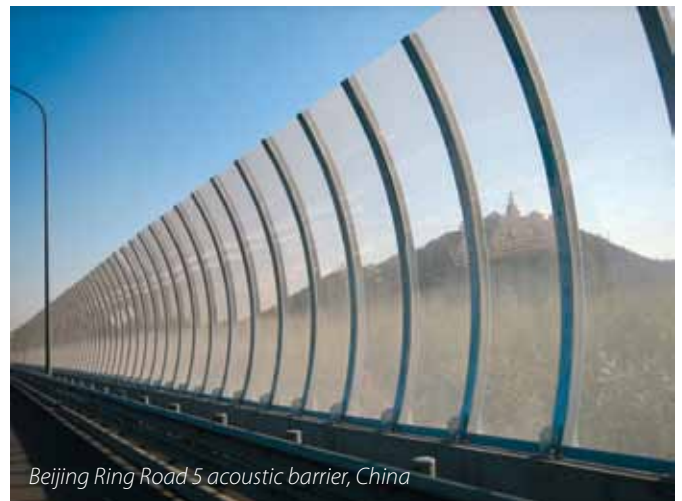

Beijing Ring Road 5 acoustic barrier, China

Weight

The specific gravity of PALSUN & PALTUF sheets is 1.2, which is about half that of glass. The following table compares the weight of PALSUN & PALTUF sheets of various thicknesses, and glass.

Sheet Thickness		PALSUN & PALTUF Weight		Glass Weight	
mm	in.	kg/m ²	lb/ft ²	kg/m ²	lb/ft ²
2	0.08	2.40	0.491	4.90	1.00
3	0.12	3.60	0.737	7.34	1.50
4	0.16	4.80	0.983	9.80	2.00
5	0.20	6.00	1.23	12.24	2.51
6	0.24	7.20	1.47	14.68	3.00
8	0.31	9.60	1.97	19.60	4.01
10	0.31	12.00	2.46	24.48	5.01

Chemical Resistance

The mechanism of chemical attack on PALSUN & PALTUF differs significantly from the mechanism of corrosion of metals, which results in a gradual loss of surface material as a result of electrolytic action by the relevant chemicals. In the cases where chemical attack on polycarbonate sheet occurs, all or a portion of a range of effects can be observed. Ethylene-chloride, chloroform, tetrachloroethane, m-cresol, pyridene and other chemicals can cause partial dissolution of polycarbonate. Swelling agents include benzene, chlorobenzene, tetralin, acetone, ethyl acetate, acetonitrile and carbontetrachloride. Additional effects include color change and/or whitening. These effects may not always lead to product failure, especially for non-loaded sheets. Nevertheless, the level of measured mechanical properties will be significantly reduced. The most critical effect of chemical attack is stress cracking or crazing, which may range in size from being visible to the naked eye to being only observable under a microscope. Stress cracks will always result in sheet failure which will emanate from areas of greatest stress (screws, fixings, bends, etc.)

PALSUN & PALTUF are generally not recommended for use with acetone, ketones, ethers, and aromatic and chlorinated hydrocarbons in addition to aqueous or alcoholic alkaline solutions, ammonia gas and its solutions and amines.

PALSUN & PALTUF are resistant to mineral acids, many organic acids, oxidizing and reducing agents, neutral and acid salt solutions, many greases, waxes and oils, saturated, aliphatic and cycloaliphatic hydrocarbons and alcohols, with the exception of methyl alcohol. The resistance of polycarbonate to water may be described as good up to approximately 60°C. At higher temperatures, degradation occurs, the extent of which depends on time and temperature. Polycarbonate should therefore not be exposed for long periods of time to hot water. However, brief contact with hot water has no effect. For example, polycarbonate tableware can be washed over 1000 times in a dish washing machine with no adverse effects being observed.

For a wide listing of the resistance of PALRAM polycarbonate products to common chemicals and other corrosive media please refer to "Chemical Resistance of Polycarbonate Products" pamphlet (Available at the PALRAM web site).

Adhesives and Sealants

Adhesives and sealants are often required when installing PALSUN. Detailed information on compatible adhesives and sealants can be found in the pamphlet "Recommended Adhesives and Sealants for Polycarbonate Products".



PALSUN Gas station light fixtures

Determination of Required Sheet Dimensions

The information below is presented to assist in ordering the required dimensions.

Determination of Thickness

In order to determine the required thickness, the following table lists the sheet thickness required for a given wind load and width (at the narrow side of the sheet).

Width		Wind Load - Pa* or N/m ² (psi)									
		400 (0.06)		800 (0.12)		1200 (0.17)		1600 (0.23)		2000 (0.29)	
mm	(in.)	Thickness		Thickness		Thickness		Thickness		Thickness	
mm	(in.)	mm	in.	mm	(in.)	mm	(in.)	mm	(in.)	mm	(in.)
600	(24)	3	(0.12)	4	(0.16)	5	(0.2)	6	(0.24)	8	(0.31)
800	(31)	4	(0.16)	5	(0.20)	6	(0.24)	6	(0.24)	8	(0.31)
1000	(39)	5	(0.20)	6	(0.24)	8	(0.31)	8	(0.31)	10	(0.39)
1200	(47)	6	(0.24)	8	(0.31)	8	(0.31)	10	(0.39)	10	(0.39)
1400	(55)	8	(0.31)	10	(0.39)	10	(0.39)	12	(0.47)	12	(0.47)
1600	(63)	8	(0.31)	10	(0.39)	12	(0.47)	12	(0.47)	NS**	
1800	(71)	10	(0.39)	12	(0.47)	12	(0.47)	NS**		NS**	
2000	(79)	10	(0.39)	12	(0.47)	NS**		NS**		NS**	

* For wind load in kg/m², multiply value by 0.1 (e.g. 400 N/m² = 40 kg/m²)

** NS - Required thickness exceeds largest available standard thickness (12mm or 0.47in.).

Example:

If the wind load is 800 N/m² and the width of the sheet is 1200mm, a sheet of 8mm thickness should be used.

But if for the same wind-load the width of the sheet is 1600mm, a sheet of 10mm thickness should be used.

Determination of Sheet Size

Due to thermal expansion, PALSUN & PALTUF sheets have to be cut accurately at predetermined lengths smaller than the dimensions of the frame. At the end of the frame, clearance must be left for expansion. The tables and diagram on the next page explain how to calculate the required sheet dimension. In addition, there is a table showing the expansion clearance necessary for various sizes of PALSUN & PALTUF sheets.

Installation

Choice of the Frame

PALSUN & PALTUF sheets can be mounted in most existing frames made of wood, rigid PVC, aluminum or other metals. It is recommended to use neoprene or EPDM packing (never use soft PVC) to secure the sheet in its frame, rather than fixing with screws. Butyl rubber sealing strip or silicone sealant (PALRAM has tested and recommends Dow Corning Q3-7098 or Q3-3793 and Novasil S 64) are also permissible. A list of compatible adhesives and sealants appears on the leaflet, "Adhesives and Sealants Compatible with Polycarbonate Sheets".

Adjusting The Sheet to Frame Dimensions

("c" and "d" refer to the indicated dimension in the diagram shown below).

If sash dimension "c" or "d" is:	Trim sheet by:
300 mm (11.8 in.)	1 mm (0.04 in.)
300 mm (11.8 in.) - 700 mm (27.6 in.)	2 mm (0.08 in.)
700 mm (27.6 in.) - 1000 mm (39.4 in.)	3 mm (0.12 in.)
1000 mm (39.4 in.) - 1300 mm (51.2 in.)	4 mm (0.16 in.)
1300 mm (51.2 in.) - 1700 mm (66.9 in.)	5 mm (0.20 in.)
1700 mm (66.9 in.) - 2000 mm (78.7 in.)	6 mm (0.24 in.)
2000 mm (78.7 in.) - 2300 mm (90.6 in.)	7 mm (0.28 in.)
2300 mm (90.6 in.) - 2700 mm (106 in.)	8 mm (0.31 in.)
2700 mm (106 in.) - 3000 mm (118 in.)	9 mm (0.35 in.)

Sheet Thickness Required for Given Sheet Width* and Rabbet Depth. ("a" and "e" refer to the indicated dimensions in the diagram shown below).

Width* (a)	Thickness	Rabbet Depth (e)
700 mm (28 in.)	3 mm (0.12 in.)	15-20 mm (0.6 - 0.8 in.)
900 mm (35 in.)	4 mm (0.16 in.)	15-20 mm (0.6 - 0.8 in.)
1100 mm (43 in.)	5 mm (0.20 in.)	15-20 mm (0.6 - 0.8 in.)
1300 mm (51 in.)	6 mm (0.24 in.)	20-30 mm (0.8 - 1.2 in.)
1500 mm (59 in.)	8 mm (0.31 in.)	20-30 mm (0.8 - 1.2 in.)
1700 mm (67 in.)	10 mm (0.39 in.)	20-30 mm (0.8 - 1.2 in.)
1900 mm (75 in.)	12 mm (0.47 in.)	20-30 mm (0.8 - 1.2 in.)

*Width refers to the smaller dimension.

Example Frame

Legend

- a ... Sheet width
- b ... Sheet length
- c ... Sash width
- d ... Sash length
- e ... Edge engagement
- f ... Thermal expansion allowance
- g ... Rabbet depth = $\frac{1}{2}f + e$

Mechanical Fastening

PALSUN & PALTUF sheets can be fastened with nuts and bolts, providing that several points be kept in mind:

- Never use rivets - they apply too much force and may cause cracks in the sheets.
- Always drill a slightly over-sized hole to compensate for thermal expansion.
- Never use soft PVC washers!
- Use neoprene and aluminum washers to distribute the load.
- When using mechanical fasteners, they should be evenly spaced to avoid stress accumulation at particular points.
- With nuts and bolts, tighten moderately and use only rust-free materials.
- Wherever possible, a "floating sheet in frame" is preferable, similar to glass, and without mechanical drilled fasteners.

Treatment of Sheets after Installation

The polyethylene masking must be removed immediately after installation. The polyethylene masking covers the sheet to protect it during handling, storage, and installation. If it is removed at a later date (In hot climates, even 24 hours after installation is completed may be too late), it will be very difficult if not impossible to remove.

PALSUN & PALTUF sheets may be cleaned by carefully following the instructions on page 25.

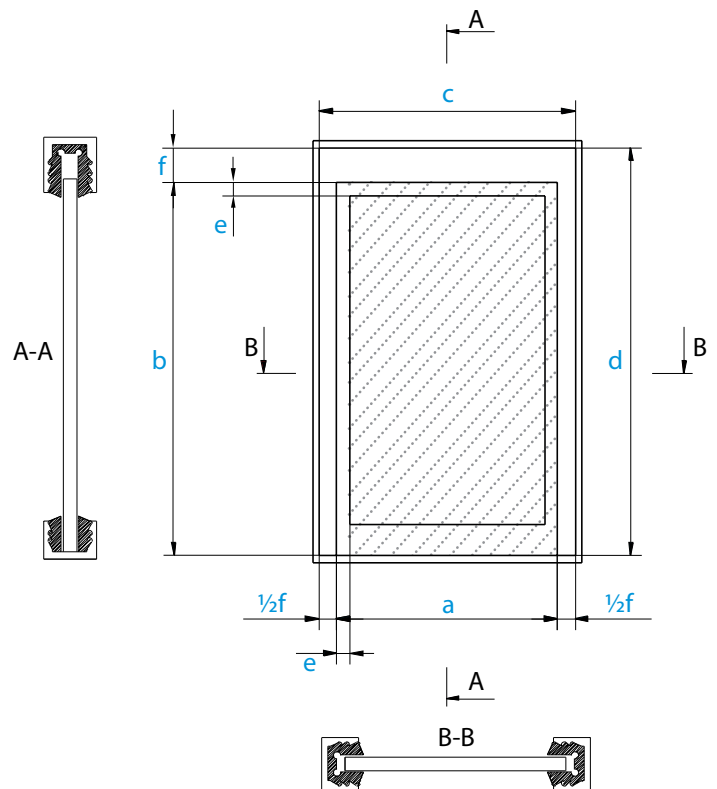

Working With PALSUN® & PALTUF®

PALSUN & PALTUF can be cut, sawed, drilled, bent - hot or cold, bonded and thermoformed. Detailed instructions appear in the "PALSUN Technical Manual".

Cleaning

PALSUN & PALTUF sheets can easily be cleaned with a soft cloth made from 100% cotton using generous amounts of detergent and water. It is best to use mild dish cleaning preparations. Commercial spray cleaners are available. Please consult with your local PALRAM agent or representative for recommended commercial preparations available locally.

Sawing and Cutting

PALSUN & PALTUF sheets can be cut with band-saws, handsaws, circular saws and other cutting tools. (Refer to the "PALSUN Technical Manual"). Notwithstanding the multiple possibilities, the following table indicates the cleanest cutting options.

Property	Circular Saw	Band-Saw
Clearance Angle	20-30°	20-30°
Flake Angle	15°	0.5°
Cutting Speed	180-250 m/min (590-820 ft/min)	200-250 m/min (650-820 ft/min)
Blade or Band Speed	1800-2400 m/min (5900-7870 ft/min)	600-1000 m/min (1970-3280 ft/min)
Tooth Spacing	2-5 mm (0.08-0.2 in.)	1.5-2.5 mm (0.06-0.10 in.)

**Band-saws, routers or shears are preferable to circular saws for single sheets of less than 3mm (0.12 in.) thickness.*

Bonding

It is possible to bond PALSUN & PALTUF sheet to itself and to other materials. Please consult the "PALSUN Technical Manual" (Available at the PALRAM web site).

Bending

Cold Bending

PALSUN & PALTUF sheets may be installed with a stressed curve to create an arch or dome, as long as the curve and resulting stress is within the specified limits. This stress will fall within an acceptable limit and there will be no effect on the sheet characteristics if the magnitude of the radius is at least 200 times that of the sheet thickness, as indicated in the following table.

Radius Desired mm (in.)	Maximum Sheet Thickness mm (in.)
600 (24)	3 (0.12)
800 (31)	4 (0.16)
1000 (39)	5 (0.20)
1200 (47)	6 (0.24)
1600 (63)	8 (0.31)

Hot Line Bending

If the polyethylene masking was removed before processing, verify that the sheet is clean. If not, clean following the instructions at the bottom of the next column. Using this method, PALSUN or PALTUF sheet is locally heated to 150-160 °C (300-320 °F) with a radiation heater (e.g. electrical resistance wire). When using single-sided heating, the sheet must be turned over several times. After heating, the sheet is bent to the desired angle. Due to immediate relaxation during bending and in order to obtain the desired angle, an over-bend might be required in hot line bending.

Stress Level

Both cold and hot bending (if the sheet is not heated sufficiently) PALSUN & PALTUF sheet induces stress in the sheet. The residual stresses will reduce the impact strength of the material along the bend and may limit the use of this method to less demanding applications. Almost completely stressless bends may be obtained using the annealing method (heating of the bent sheet).

Thermoforming

PALSUN and PALTUF sheets intended for thermoforming with masking must be ordered specially and is supplied with a polyethylene masking intended for thermoforming. This masking must not be printed or labeled except for ink jet along the edge because printing affects the optical quality of the thermoformed article. Thermoforming machines vary in their performance. It is essential that you test PALSUN and PALTUF sheets with masking in your thermoforming process before starting production. If PALSUN and PALTUF sheets intended for thermoforming were not ordered, or if this is not stated on the packing slip, then the polyethylene masking must be removed prior to thermoforming. In this case, verify that the sheet is clean prior to processing. If necessary, clean the sheet following the instructions on page 25. Working in a dust free environment is also required. PALSUN and PALTUF sheets must be pre-dried prior to thermoforming. Detailed instructions for pre-drying and thermoforming appear in the "PALSUN Technical Manual".

Important!

Sheets intended for thermoforming are supplied with a special polyethylene masking. Please specify when ordering PALTUF or PALSUN for thermoforming.

*PALSUN transparent wind shields
Hangzhou Bay Bridge (Hangzhou, China)*



Inasmuch as PALRAM Industries has no control over the use to which others may put the material, it does not guarantee that the same results as those described herein will be obtained. Each user of the material should make his own tests to determine the material's suitability for his own particular use. Statements concerning possible or suggested uses of the materials described herein are not to be construed as constituting a license under any PALRAM Industries patent covering such use or as recommendations for use of such materials in the infringement of any patent. PALRAM Industries or its distributors cannot be held responsible for any losses incurred through incorrect installation of the material. In accordance with our company policy of continual product development you are advised to check with your local PALRAM Industries supplier to ensure that you have obtained the most up to date information



PALRAM Industries Ltd.

PALRAM Israel Ltd.

Tel ▶ (972) 4 8459 900
Fax ▶ (972) 4 8459 980
E-mail ▶ palram@palram.com
Web ▶ www.palram.co.il

PALRAM Americas Inc.

Tel ▶ 610 285 9918
Fax ▶ 610 285 9928
E-mail ▶ palramamericas@palram.com
Web ▶ www.palramamericas.com

PALRAM Europe Ltd.

Tel ▶ (44) 1302 380776
Fax ▶ (44) 1302 380788
E-mail ▶ sales.europe@palram.com
Web ▶ www.palram.com

